

WOVENFLOORING

BY DICKSON

INSTALLATION GUIDELINES





> CONTENTS

04

PRIOR TO
INSTALLATION

10

INSTALLATION
OF TILES

07

INSTALLATION
OF ROLLS

14

INSTALLATION
OF PLANKS
AND SHAPES

Retrouvez ce guide en français en version digitale sur : www.dickson-constant.com - Find these installation guidelines in English in a digital version on : www.dickson-constant.com - Diese Verlegeanleitung gibt es auch auf Deutsch in einer digitalen Version unter : www.dickson-constant.com - La versión digital en español de esta Guía de instalación está disponible en www.dickson-constant.com - La versione digitale della guida per la posa è disponibile in italiano su www.dickson-constant.com - Deze plaatsingsgids staat online in het Nederlands op www.dickson-constant.com - Encontre este guia em português em versão digital em: www.dickson-constant.com - Tämän oppaan suomenkielinen digitaalinen versio on saatavilla osoitteessa www.dickson-constant.com - Ta instrukcja układania jest dostępna po polsku w wersji cyfrowej na stronie www.dickson-constant.com - Bu montaj kılavuzunun dijital versiyonu www.dickson-constant.com adresinde Türkçe olarak da mevcuttur - この日本語ガイドブックのデジタル版については、次のサイトをご覧ください: www.dickson-constant.com

THE ART OF WEAVING



Thank you for choosing Dickson® woven flooring. Soon, you will be taking your first steps on this totally innovative material.

Invented based on extensive research and perfected thanks to Dickson's tried and true experience and know-how, this flooring combines the durable quality and convenient upkeep of vinyl flooring with the aesthetic appeal and enjoyable texture of textile flooring.

We now invite you to discover our smart tips for installing with the aim of ensuring your utmost satisfaction.

FRAYGUARD®
CLEAN CUT
by **DICKSON®**

THE FIRST WOVEN VINYL FLOORING THAT DOESN'T FRAY

The FrayGuard® technology developed by Dickson minimizes the common phenomenon of fraying when cutting carpeting and boosts the durability of the weave. It guarantees clean-cut edges for fast, efficient, impeccable installation.

The information contained in these guidelines may change without warning. It is therefore essential that those responsible for installing this new flooring keep a close eye on any changes that may occur in the product or the installation techniques. It is also recommended that the material be thoroughly examined prior to installation to avoid any visible flaws in the final outcome. Once the material has been installed, it cannot be returned under any circumstances whatsoever.

DICKSON®
woven flooring

> PRIOR TO INSTALLATION

> Acclimate the flooring

- Before you start to install the flooring, **you must give it time to adjust to the room's climate** :
 - **For rolls** : 24 hours prior to installation, unroll the flooring and spread it out in the room where you plan to install it.
 - **For tiles** : 48 hours prior to installation, lay the tiles out in their original packaging on a flat surface.
- Make sure the room's air temperature and humidity levels are normal (above 15°C / 59°F with relative humidity between 30% and 60%).

> Prepare the surface to be covered

Make sure the subflooring is :

- **Clean** : dust and wash the surface, eliminate all traces of plaster, paint, grease, oil, rudiments, etc.
- **Flat, hard and durable** : without any cracks ($\geq 0,3$ mm) or micro-cracks ($< 0,3$ mm); if the surface is irregular or has any residue such as glue or asphalt, we recommend using a self-smoothing resurfacing primer (get in touch with a resurfacing primer products manufacturer).
- **Perfectly dry and waterproof** : it is essential that you abide by all national rules and regulations in effect as regards humidity controls for the surface that is to be covered.



IMPORTANT DETAILS

- *Vinyl flooring creates an impervious membrane that prevents underlying moisture from evaporating. Excess water build-up may cause immediate or long-term damage (detachment, bubbles, deterioration of the subflooring or resurfacing primer coat).*
- *Make sure to systematically check the temperature and moisture level of the surface that is to be covered before installing the vinyl flooring. In general, the temperature of the surface to be covered should be above 10°C (room temperature about 15°C | 59°F) and the moisture level should not be above 4.5% in weight.*

> Special conditions

- When installing on stairways with significant traffic, nosing must be used.
- When installing on surfaces with low temperature under floor heating (note: temperature should never exceed 28°C / 82,4°F at any contact point) :
 - Respect the surface drying time.
 - The heating system should be active for 4 weeks before installing the floor covering.
 - The heating system should be turned off 48 hours before initiating the floor covering installation process, including preparation of the subflooring.
 - Wait at least 48 hours after installing the floor covering before turning progressively the under floor heating system back on.
 - Avoid drastic shifts in temperature; gradually adjust the thermostat in stages of no more than 5°C / 41°F per day.



TOOLS NEEDED

- Chalk or pencil
- Ruler and measuring tape
- Stanley knife and straight-edge level for cutting
- Grooved spatula for the glue
- Steam roller
- 50 kg smoothing roller
- Acrylic glue or permanent adhesive for vinyl flooring (refer to the recommendations of gluing below) that is compatible with the back side of the flooring.



IMPORTANT NOTE

Before you start to install the flooring, carefully inspect it under bright lighting to check for any visible flaws. Damaged or flawed material should never be installed under any circumstances. If any flaws are detected, immediately contact your reseller.



SMART TIP

In planning the overall works timeline, schedule the final phase to be the flooring installation to avoid damaging it while the other work is being done on the room. If this is not possible, make sure to protect it with a plastic sheet or cardboard.





ADHESIVE RECOMMENDATIONS

The adhesives listed below have been tested and approved by their manufacturers for installation of our flooring. In case of occasional need to use a contact adhesive, do not use solvent-based neoprene glue. Prefer polyurethane or aqueous contact adhesives.

Important note ! Always read and follow the adhesive manufacturer's instructions and recommendations with utmost care.

ACRYLIC ADHESIVES FOR DIRECTLY GLUING (for tiles, rolls and shapes):

BOSTIK	F BALL	THOMSIT	UZIN
Stix A300 Multi Floor	F44	Thomsit K188E	KE 2000S
Stix A800 Premium	F45	Thomsit K188S	KE 66
Sadertac V6	F46	Thomsit K150	KE 28
Sadertech V8	F48 Plus	Thomsit K188	KE 68
	F49	Thomsit UK800	

XL BRANDS	MAPEI	CÉGÉCOL / SIKA	HB FULLER
5900 (USA)	Ultrabond ECO 370	Cégé 100 HQ-T Premium	TEC 540
	Ultrabond ECOV4SP	Cégé 100Technic	TEC 522
		SikaBond 135 PVC	
		SikaBond 150 Premium Floor	

STAUF	COLLAK
High-Tack D737 (USA)	WA-1040

TACKIFIER (compatible only with tiles and XL tiles):

In the event of use on an absorbent surface, apply an adapted primer in order to keep the characteristics of the permanent adhesive (please contact the adhesive manufacturer)

BOSTIK	F BALL	THOMSIT	UZIN
Fix A760Tech	F41 (USA)	Thomsit T435	U2500

XL BRANDS	MAPEI	HB FULLER	STAUF
2230 (USA)	Ultrabond ECO Fix	TEC 542	D764

COLLAK
WA-25

ALTERNATIVE INSTALLATIONS (for time-limited projects):

Discover the possibility of innovative and environmentally friendly alternative installations using **IOBAC MagTabs magnetic pads** or **AVERY DENNISON Flooring Adhesive FT4361 stickers**. These methods offer a faster, greener and more flexible installation.

By reducing installation time and the use of chemicals, and offering greater flexibility, they meet the needs of time-limited projects, encouraging a circular economic approach. When you remove the tile, the substrate remains intact, as does the Dickson Woven Flooring tile, which can therefore be easily reused in another environment.

These installations are not covered by the Dickson commercial warranty.

> INSTALLATION OF ROLLS

> Basic principles

Your Dickson® floor covering is delivered in 2 m / 78,74 " widths and is installed by directly gluing it to the subflooring.

As with all woven flooring, it may have natural structural discrepancies. Depending on the colour and the weave, the seams will be more or less visible and will enhance the flooring's "authentic carpeting" look.

- The strips should be oriented toward the main window (light direction) or lengthwise within the room (traffic direction).
- In hallways, the strips should be laid in the same direction as the majority of the traffic, except when otherwise indicated in the Market Specific Documents.
- Strips should all be laid in the same direction to ensure a harmonious look; use the arrows on the back of the flooring as guides.
- Check the straightness of the selvages by placing the strips edge to edge. Make a double cut if the selvages have been damaged or the joint is not aesthetic.
- As much as possible, avoid seams between strips in areas where heavy traffic is expected.
- Avoid seams at either end; finish off the open ends with a metal trim.
- Within any given room, make sure to use flooring strips from the same batch.



SMART TIPS

In rooms with direct access to the outdoors, plan to install an absorbent doormat at the entrance or another protection system that keeps the abrasive particles and moisture at the entrance. It will collect up to 80% of the dirt and moisture brought into the room. This will provide many benefits, particularly in terms of reducing maintenance costs and extending the life of your floor covering.



APPLICATION OF THE ADHESIVE

See the adhesive recommendations on page 6.
Follow the adhesive manufacturer's instructions to the letter and respect both the weight and timing specifications.



IMPORTANT NOTE

The woven structure adds character to the look of your flooring and naturally plays with the light. Varying with the colour and layout direction, the deep and subtle hues of your flooring change according to the lighting and perspective.

Our Dickson flooring is composed of a weave of PVC-coated polyester monofilaments combined with an acoustic and technical undercoat by heat-setting and coating. The action of heat, at the heart of our production process, allows the different elements of our products to melt together, thus ensuring their resistance to wear and tear and perfect dimensional stability. Thus, the discrete amalgam of polymers can be detected on the wear side without altering the quality of our products in any way.

> Laying the strips



1. Position the strips so that the edges overlap by at least 4 cm / 1,58".



2. Using a ruler and Stanley knife or other adapted tools (railcut of Wolf, tiptop of Janser...), proceed with the double cut. Cut through both thicknesses at once, in the middle of the two strips' overlap. Remove remnants and check the seam's quality. If the cut is not perfect, renew the operation.



3. Mark the exact position of the initial strip while making sure to leave enough room in both directions for the levelling.



4. Position the strip along the line you've drawn on the subfloor.

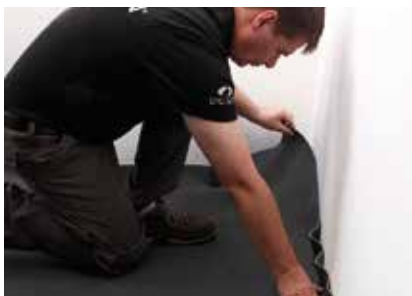

The leeway allocated for cuts runs along the walls or baseboards.



5. Fold half of the strip back.



6. Uniformly apply the glue to the first half of the strip using a grooved spatula, but without allowing glue strands to form.



7. Observe the appropriate flash time, then lay the flooring strip into the adhesive.



8. Refold the strips, carefully joining the two edges for a smooth seam and ensure the seal with the seam roller; then smooth out the entire area with the heavy roller to remove any air bubbles.

Repeat the procedure for the remaining strips.



9. Cut the outer edges of the floor covering to fit the shape of the room, following along the walls, baseboards, pipes and other notches as closely as possible :

- a. Follow the detailed edge of the walls if baseboards will be installed afterwards.
- b. Follow the detailed edge of the baseboards, if they are already in place.



10. Press firmly into place, working out any air bubbles with the smoothing roller. Fold up the other side of the strip and repeat steps 6, 7, 8 and 9.

> When the flooring installation is complete :

The floor covering should be clean and free of any glue or other remains from the installation process.

Allow the flooring to set. The following waiting periods must be respected :

- For normal traffic zones, wait 24 hours after installation is complete before using the room.
- Wait 72 hours before proceeding with the first deep cleaning (see care & maintenance).
- Wait 72 hours before placing or arranging furniture in the room.



IMPORTANT

Use felt pads or other types of protection to prevent damage from sharp objects. Never use protective devices made from rubber (the oil in the rubber can cause permanent discolouration of the flooring).

> INSTALLATION OF THE TILES

(tiles 50x50 cm / 19,69"x19,69" and XL tiles 100x100 cm / 39,37"x 39,37")

> Basic principles

The installation is done either by gluing permanently, or by a non permanent installation (the tiles are trapped with the aid of a permanent tack adhesive).

As with all woven flooring, it may have natural structural discrepancies. Depending on the colour and the weave, the seams will be more or less visible and will enhance the flooring's "authentic carpeting" look.

Arrangement of the tiles (DTU 53.2): unless otherwise specified in the Market Specific Documents:

- Each room is considered separately
- Within any given room,
 - for a monolithic installation, it is imperative that the tiles come from the same batch and that the boxes are mixed together.
 - for a checkerboard pattern, mixing of the batches is possible, but it is imperative to mix the boxes.
- Whenever possible, the laying must be designed in such a way that at the periphery of the room the cuts are balanced and the width of the tiles is greater than 1/2 tile.

A good arrangement of the tiles will promote a good aesthetic appreciation of the work. By performing the laying as described below, the cuts can be balanced at the periphery of the room to be covered.

Set aside one or two packs of tiles to quickly and easily replace any tiles that might eventually become damaged or worn out over time.



IMPORTANT

Before you start to install the flooring, carefully inspect it under bright lighting to check for any visible flaws. Damaged or flawed material should never be installed under any circumstances. If any flaws are detected, immediately contact your reseller.

The woven structure adds character to the look of your flooring and naturally plays with the light. Varying with the shape, colour and layout pattern, the deep and subtle hues of your flooring change according to the lighting and perspective.

Our Dickson flooring is composed of a weave of PVC-coated polyester monofilaments combined with an acoustic and technical undercoat by heat-setting and coating. The action of heat, at the heart of our production process, allows the different elements of our products to melt together, thus ensuring their resistance to wear and tear and perfect dimensional stability. Thus, the discrete amalgam of polymers can be detected on the wear side without altering the quality of our products in any way.



SMART TIP

In rooms with direct access to the outdoors, plan to install an absorbent doormat at the entrance or another protection system that keeps the abrasive particles and moisture at the entrance. It will collect up to 80% of the dirt and moisture brought into the room. This will provide many benefits, particularly in terms of reducing maintenance costs and extending the life of your floor covering.

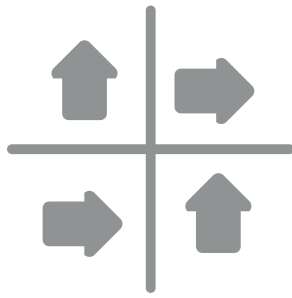

Checkerboard pattern

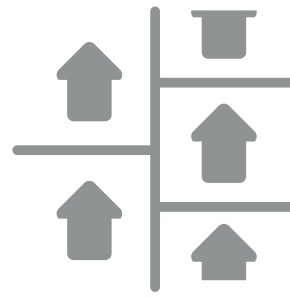

Ashlar pattern

Our ranges, all available in tiles, were designed for checkerboard installation or Ashlar pattern installation, the perfect solution for a smooth rendering. In the case of an installation on raised access floor, we recommend you to opt for an ashlar pattern layout that will bring you the best aesthetic result: the seams will be almost invisible.

> Positioning the tiles in a checkerboard pattern

a. Drawing of two baseline axes to start the layout

Room dimensions: $L \times w$. Tiles dimensions: d in the same measuring unit.

Draw two baseline axes across the middle of the room.

Calculate the number N of tiles needed to cover the length of the room: $N = L / d$. Round « N » up to the nearest integer.

- If « N » is even, you should start the laying of the tiles along the drawn axis
- If « N » is odd, offset the axis by half a tile ($d/2$) and start the laying along this new axis.

Repeat the same calculation for the width of the room (w): calculate the number n of tiles needed to cover the width of the room: $n = w / d$. Round « n » up to the nearest integer.

- If « n » is even, you should start the laying of the tiles along the drawn axis
- If « n » is odd, offset the axis by half a tile ($d/2$) and start the laying along this new axis.

If N and n are even

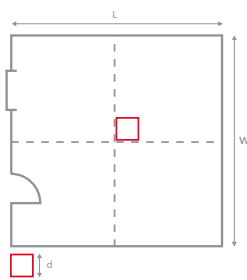

If N is odd and n even

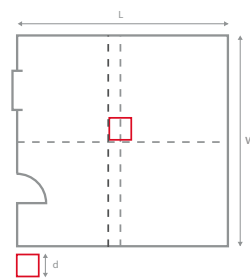

If N is even and n odd

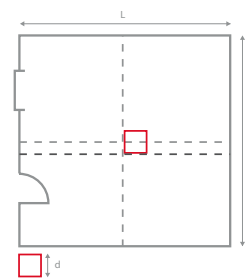

If N and n are odd

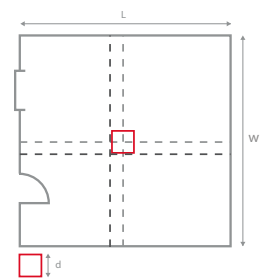

In case of a small area, move the axes close to the entrance.

b. Glue a surface of reasonable size so that the tiles can be applied in the glue during the working time of the glue.

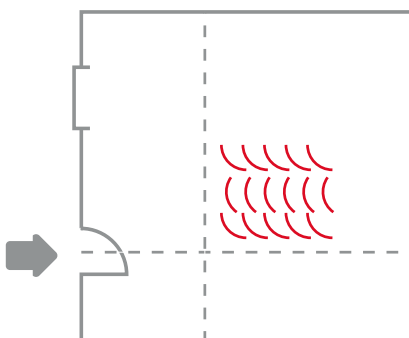

APPLICATION OF THE ADHESIVE

See the adhesive recommendations on page 6. Follow the adhesive manufacturer's instructions to the letter and respect both the weight and timing specifications.

c. Position the first tile at the intersection between the two axes and begin to lay the tiles using the “step” method.

- **Squaring** : check the alignment of the tiles often
- **Tightening** : check regularly to make sure the 4 sides of each tile are closely lined up.

If you do not use the step method when securing the tiles, they may not align properly and could thus lead to gaps or openings in the seams.

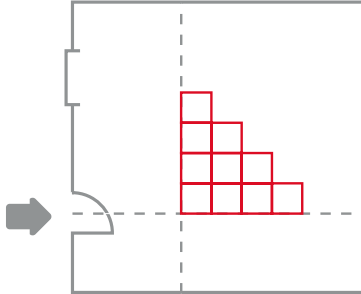

d. Smooth down the tiles: this process is mandatory and must be done in two stages:



Smooth down the joints using the small seam roller.



Smooth down the entire flooring area using the large, heavy roller.

e. Repeat the smoothing process across the entire room.

> Positioning the tiles in an Ashlar pattern

a. Draw two baseline axes across the middle of the room.

Room dimensions: $L \times w$. Tiles dimensions: d in the same measuring unit.

Calculate the number N of tiles needed to cover the length of the room: $N = L / d$. Round « N » up to the nearest integer.

If « N » is even, start the laying of the tiles along the drawn axis

If « N » is odd, offset the axis by half a tile ($d/2$) and start the laying along this new axis

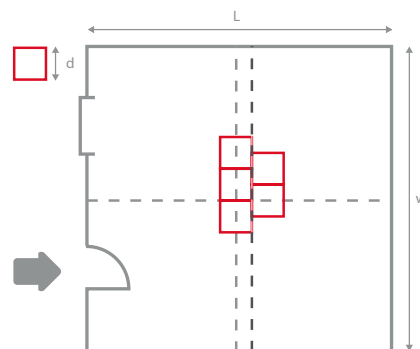
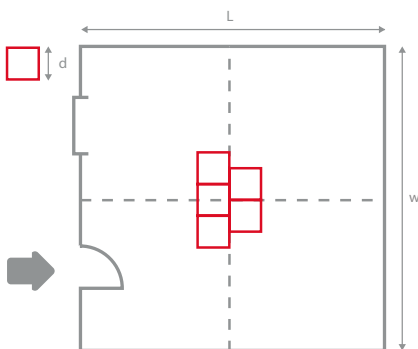

b. Glue a surface of reasonable size so that the tiles can be applied in the glue during the working time of the glue.

c. Position the first tile at the intersection between the two axes and begin to lay the tiles using the “step” method.

- **Squaring** : check the alignment of the tiles often
- **Tightening** : check regularly to make sure the 4 sides of each tile are closely lined up.

If you do not use the step method when securing the tiles, they may not align properly and could thus lead to gaps or openings in the seams.



APPLICATION OF THE ADHESIVE

See the adhesive recommendations on page 6.

Follow the adhesive manufacturer's instructions to the letter and respect both the weight and timing specifications.

d. Smooth down the tiles: this process is mandatory and must be done in two stages:



Smooth down the joints using the small seam roller.



Smooth down the entire flooring area using the large, heavy roller.

e. Repeat the smoothing process across the entire room.

> When the flooring installation is complete :

The floor covering should be clean and free of any glue or other remains from the installation process.

Allow the flooring to set. The following waiting periods must be respected :

- For normal traffic zones, wait 24 hours after installation is complete before using the room.
- Wait 72 hours before proceeding with the first deep cleaning (see care & maintenance).
- Wait 72 hours before placing or arranging furniture in the room.



IMPORTANT

Use felt pads or other types of protection to prevent damage from sharp objects. Never use protective devices made from rubber (the oil in the rubber can cause permanent discolouration of the flooring).

> INSTALLATION OF PLANKS AND SHAPES

> Basic principles

The floor is installed by directly gluing it to the subflooring.

As with all woven flooring, it may have natural structural discrepancies. Depending on the colour and the weave, the seams will be more or less visible and will enhance the flooring's "authentic carpeting" look.

Arrangement of the tiles (DTU 53.2): unless otherwise specified in the Market Specific Documents:

- Each room is considered separately
- Within any given room, make sure to use flooring planks or shapes from the same batch.
- The planks or shapes should be oriented toward the main window (light direction) or lengthwise within the room (traffic direction).
- In hallways, the planks or shapes should be laid in the same direction as the majority of the traffic
- Whenever possible, the laying must be designed in such a way that at the periphery of the room the cuts are balanced and the width of the planks or shapes is greater than 1/2 plank or shape.

A good arrangement of the planks or shapes will promote a good aesthetic appreciation of the work. By performing the laying as described below, the cuts can be balanced at the periphery of the room to be covered.

Set aside one or two packs of planks or shapes to quickly and easily replace any planks or shapes that might eventually become damaged or worn out over time.



IMPORTANT

Before you start to install the flooring, carefully inspect it under bright lighting to check for any visible flaws. Damaged or flawed material should never be installed under any circumstances. If any flaws are detected, immediately contact your reseller.

The woven structure adds character to the look of your flooring and naturally plays with the light. Varying with the shape, colour and layout pattern, the deep and subtle hues of your flooring change according to the lighting and perspective.

Our Dickson flooring is composed of a weave of PVC-coated polyester monofilaments combined with an acoustic and technical undercoat by heat-setting and coating. The action of heat, at the heart of our production process, allows the different elements of our products to melt together, thus ensuring their resistance to wear and tear and perfect dimensional stability. Thus, the discrete amalgam of polymers can be detected on the wear side without altering the quality of our products in any way.



SMART TIP

In rooms with direct access to the outdoors, plan to install an absorbent doormat at the entrance or another protection system that keeps the abrasive particles and moisture at the entrance. It will collect up to 80% of the dirt and moisture brought into the room. This will provide many benefits, particularly in terms of reducing maintenance costs and extending the life of your floor covering.

> Laying of planks

Planks
25 X 100 cm
9,84 X 39,37"

XL planks
50 X 100 cm
19,69 X 39,37"

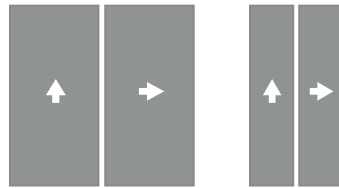

Four types of laying patterns are recommended: random joints pattern, herringbone pattern, ladder pattern and checkerboard pattern en « damier »

1. Random joints pattern

This type of pattern is done with one or several colours, with the planks or XL planks.

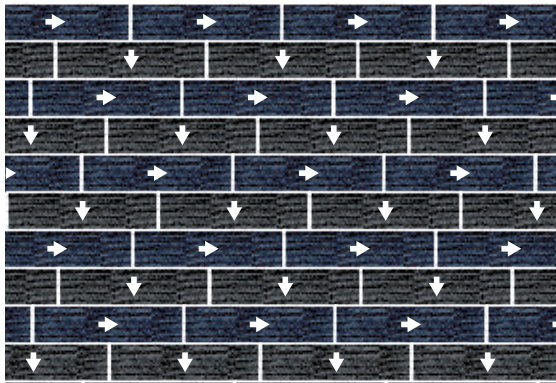

Single-colour random joint pattern of warp weave and weft weave planks.

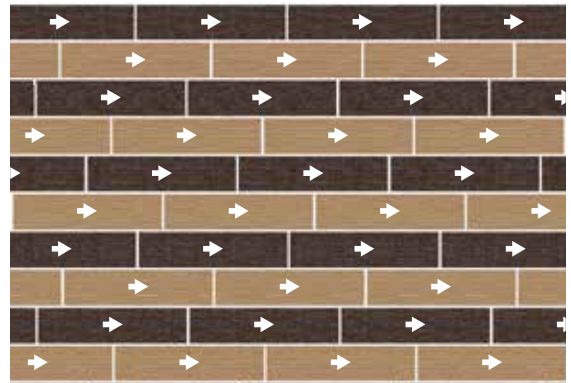

Two-colour random joint pattern with warp weave planks.

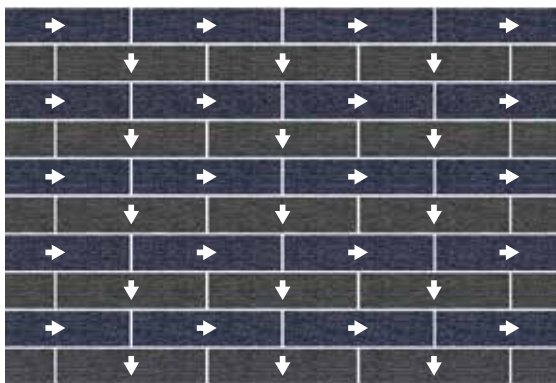

Single-colour ashlar pattern of warp weave and weft weave planks.

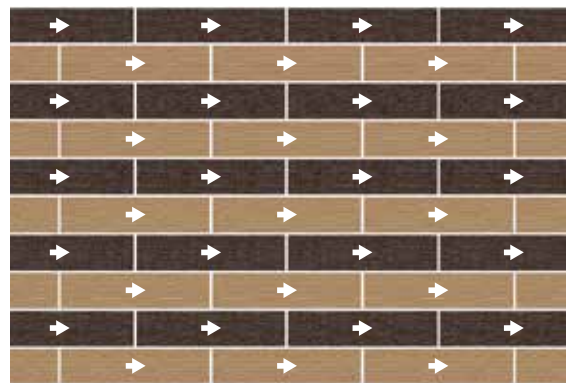

Two-colour ashlar pattern with warp weave planks.

Implementation:

Room dimensions: L x w. Planks dimensions: X (width) x Y (length) in the same measuring unit.

a. Draw two baseline axes across the middle of the room.

b. Calculate the number n of planks needed to cover the width of the room: $n = w / X$

Round n up to the nearest integer.

- If « n » is even, start the laying of the planks along the drawn axis

- If « n » is odd, offset the axis by half a plank (X/2) and start the laying along this new axis

Then, calculate the number N of planks needed to cover the length of the room: $N = L / Y$.

Round « N » up to the nearest integer.

- If « N » is even, start the laying of the planks along the drawn axis

- If « N » is odd, offset the axis by half a plank ($Y/2$) and start the laying along this new axis

If N and n are even

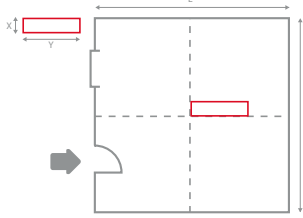

If N is odd and n even

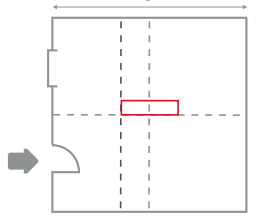

If N is even and n odd

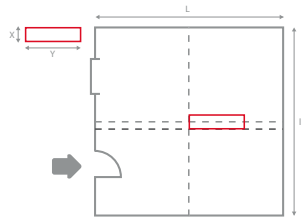

If N and n are odd

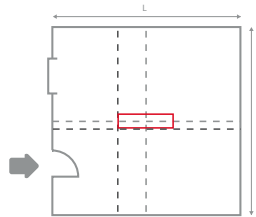

In case of a small area, move the axes close to the entrance in order to glue the whole area at once.

For a random joints pattern, the planks will be offset of at least 1/3 plank in the length direction (33 cm / 13,11").

For an Ashlar pattern, the planks will be offset of 1/2 plank in the length direction (50 cm / 19,69").

c. Glue a surface of reasonable size so that the planks can be applied in the glue during the working time of the glue.

d. Lay the first plank down like explained above.

e. Then lay the other planks around the first one.

- **Squaring** : check the alignment of the planks often
- **Tightening** : check regularly to make sure the 4 sides of each plank are closely lined up.

Failure to comply with these rules may lead to a bad lining up and could thus generate gaps or openings in the seams.

f. Smooth down the planks: this process is mandatory and must be done in two stages:



Smooth down the joints using the small seam roller.



Smooth down the entire flooring area using the large, heavy roller.

g. Repeat the smoothing process across the entire room.



APPLICATION OF THE ADHESIVE

See the adhesive recommendations on page 6.

Follow the adhesive manufacturer's instructions to the letter and respect both the weight and timing specifications.

2. Herringbone pattern:

The herringbone patterns can be declined in different ways in order to obtain different aspects. They can be made either in planks (25x100 cm/9,84x39,37"), or in XL planks (50x100 cm/19,69x39,37").



Single-colour herringbone pattern of warp weave and weft weave planks.



Two-colour herringbone pattern.



Single-colour double herringbone pattern of warp weave and weft weave planks.



Two-colour double herringbone pattern

Implementation:

a. Draw an axis to determine where to start the laying:

- If the corners of the room are 90 °, transfer the width of the room «w» and then draw the axis obtained. Mark the center of this axis. The laying will start along this axis, starting from the middle (see opposite).

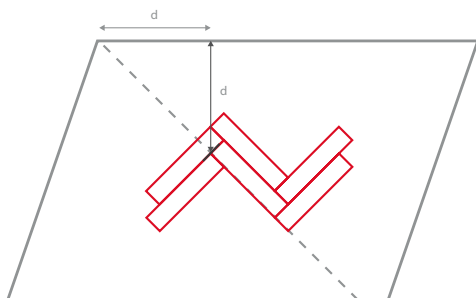
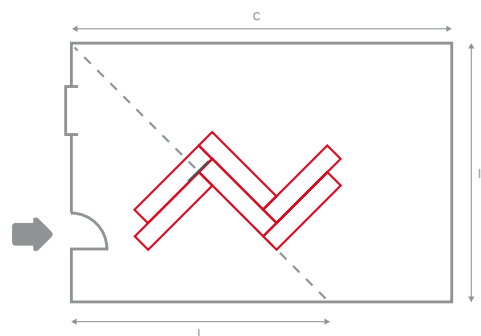

- If the walls are not at 90 °, it is necessary to draw a perpendicular to a distance «d» from an angle, after having defined a directing wall. Transfer the distance «d» on the perpendicular. Draw the axis that passes through the angle and the point obtained, extending it to the wall opposite and mark the middle of this axis. The first plank will be laid along this axis from the middle (see diagram opposite)

b. Glue a surface of reasonable size so that the planks can be applied in the glue during the working time of the glue.

c. Lay the first plank down like explained above.

d. Then lay the other planks around the first one.

- **Squaring** : check the alignment of the planks often
- **Tightening** : check regularly to make sure the 4 sides of each plank are closely lined up.

Failure to comply with these rules may lead to a bad lining up and could thus generate gaps or openings in the seams.



APPLICATION OF THE ADHESIVE

See the adhesive recommendations on page 6.

Follow the adhesive manufacturer's instructions to the letter and respect both the weight and timing specifications.

e. Smooth down the planks: this process is mandatory and must be done in two stages:



Smooth down the joints using the small seam roller.



Smooth down the entire flooring area using the large, heavy roller.

f. Repeat the smoothing process across the entire room.

3. Ladder pattern:

The ladder patterns can be declined in different ways in order to obtain different aspects. They can be made either in planks (25x100 cm/9,84x39,37"), or in XL planks (50x100 cm/19,69x39,37").

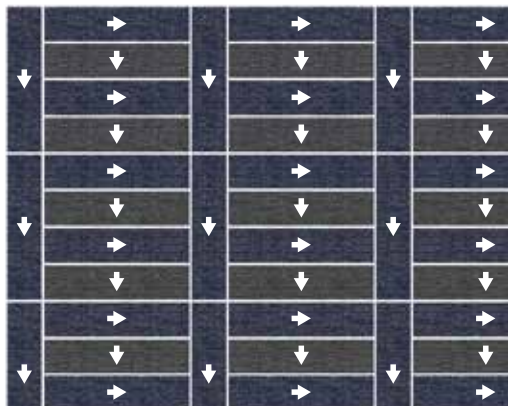

Single-colour ladder pattern of warp weave and weft weave planks.

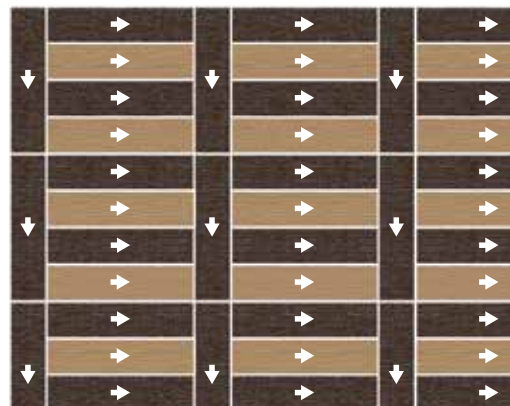

Two-colour ladder pattern.

Implementation:

Room dimensions: L x w. Planks dimensions: X (width) x Y (length) in the same measuring unit.

a. To balance the cuts, draw two axes to determine the center of the room.

b. Calculate the number n of planks needed to cover the width of the room: $n = w / X$

Round n up to the nearest integer.

We thus obtain the number of entire planks necessary to lay a row of planks over the width of the room to be covered.

If « n » is even, start the laying of the planks along the drawn axis:

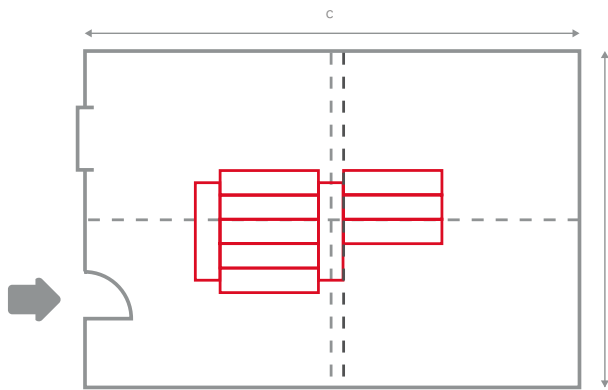

If « n » is odd, offset the axis by half a plank (X/2) and start the laying along this new axis:

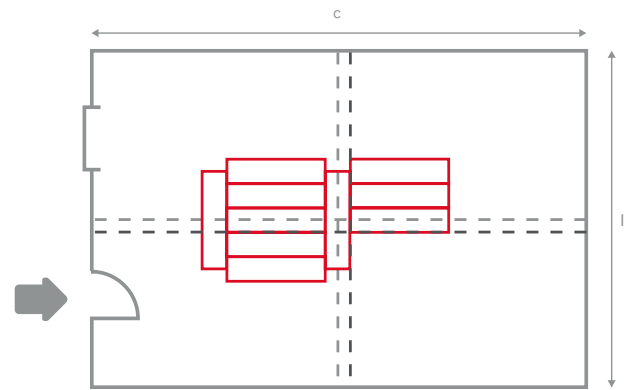

Check before beginning the installation that the cuts are balanced and of sufficient size along the length. If this is not the case, offset the traced axis by 1/2 plank in the width direction (50 cm/19,69"). See the diagram below:

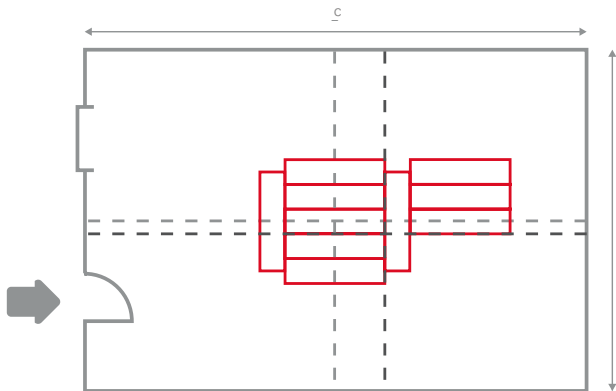

APPLICATION OF THE ADHESIVE

See the adhesive recommendations on page 6.
Follow the adhesive manufacturer's instructions to the letter and respect both the weight and timing specifications.

c. Glue a surface of reasonable size so that the planks can be applied in the glue during the working time of the glue.

d. Lay the first plank down like explained above.

e. Then lay the other planks around the first one.

• **Squaring** : check the alignment of the planks often.

• **Tightening** : check regularly to make sure the 4 sides of each plank are closely lined up.

Failure to comply with these rules may lead to a bad lining up and could thus generate gaps or openings in the seams.

f. Smooth down the planks: this process is mandatory and must be done in two stages:



Smooth down the joints using the small seam roller.



Smooth down the entire flooring area using the large, heavy roller.

g. Repeat the smoothing process across the entire room.

4. Square basket pattern:

The **square basket pattern** can be made either in planks (25x100 cm/9,84x39,37"), or in XL planks (50x100 cm/19,69x39,37"), and is either single-colour with warp weave and weft weave planks or two-colour.

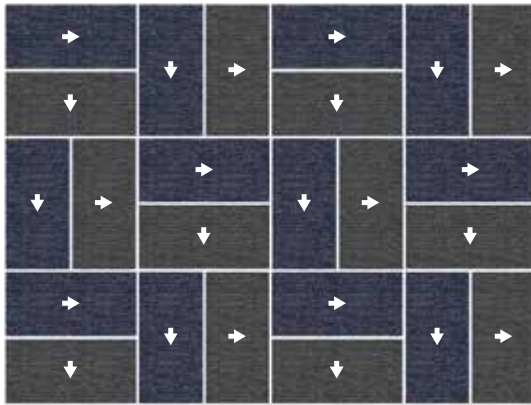

Single-colour square basket pattern of warp weave XL planks and weft weave XL planks.

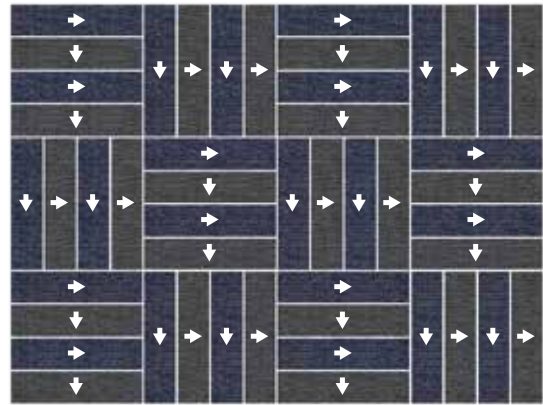

Single-colour square basket pattern of warp weave planks and weft weave planks.

Implementation:

a. Draw two axes to determine the center of the room.

In order to have balanced cuts at the periphery of the room, start laying the planks as described below:

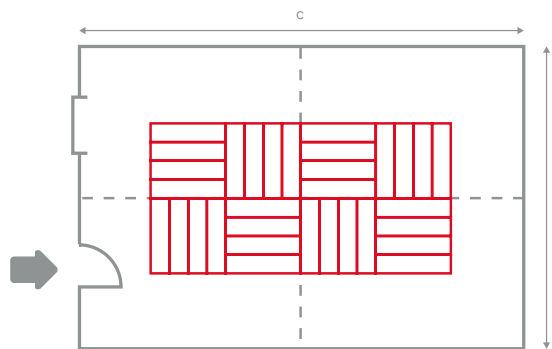

APPLICATION OF THE ADHESIVE

See the adhesive recommendations on page 6.
Follow the adhesive manufacturer's instructions to the letter and respect both the weight and timing specifications.

b. Glue a surface of reasonable size so that the planks can be applied in the glue during the working time of the glue.

c. Lay the first plank down like explained above.

d. Then lay the other planks around the first one.

- **Squaring** : check the alignment of the planks often.

- **Tightening** : check regularly to make sure the 4 sides of each plank are closely lined up.

Failure to comply with these rules may lead to a bad lining up and could thus generate gaps or openings in the seams.

e. Smooth down the planks: this process is mandatory and must be done in two stages:



Smooth down the joints using the small seam roller.



Smooth down the entire flooring area using the large, heavy roller.

f. Repeat the smoothing process across the entire room.

> Laying of hexagons

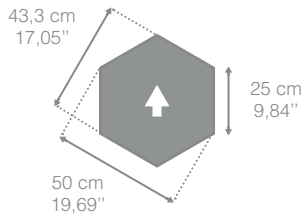

This type of shape can be laid in single-colour or several colours compositions.



Single -colour hexagons pattern.



APPLICATION OF THE ADHESIVE

See the adhesive recommendations on page 6.
Follow the adhesive manufacturer's instructions to the letter and respect both the weight and timing specifications.

Implementation:

a. Draw two axes to determine the center of the room.

In order to have balanced cuts at the periphery of the room, start laying the hexagons as described below.

b. Glue a surface of reasonable size so that the hexagons can be applied in the glue during the working time of the glue.

c. Lay the first hexagon down at the center of the room.

d. Then lay the other hexagons around the first one. The colour effect is obtained by respecting correctly the direction of installation of the hexagons.

- **Squaring** : check the alignment of the hexagons often.
- **Tightening** : check regularly to make sure the 6 sides of each hexagon are closely lined up.

Failure to comply with these rules may lead to a bad lining up and could thus generate gaps or openings in the seams.

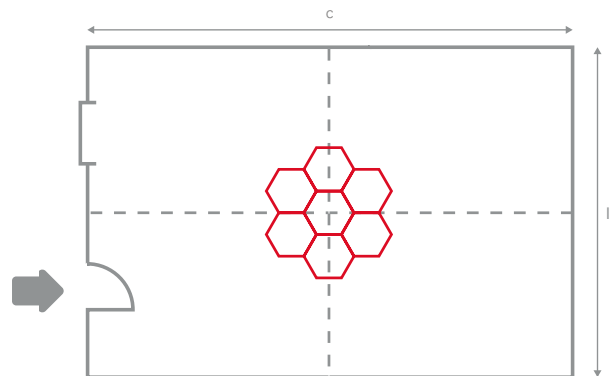

e. Smooth down the hexagons: this process is mandatory and must be done in two stages:



Smooth down the joints using the small seam roller.



Smooth down the entire flooring area using the large, heavy roller.

f. Repeat the smoothing process across the entire room.

> Laying of half-hexagons

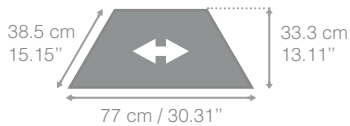

This type of shape can be laid in single-colour or several colours compositions.



Two-colour half-hexagons pattern.



APPLICATION OF THE ADHESIVE

See the adhesive recommendations on page 6. Follow the adhesive manufacturer's instructions to the letter and respect both the weight and timing specifications.

Implementation:

a. Draw two axes to determine the center of the room.

In order to have balanced cuts at the periphery of the room, start laying the half-hexagons as described below.

b. Glue a surface of reasonable size so that the half-hexagons can be applied in the glue during the working time of the glue.

c. Lay the first half-hexagon down at the center of the room.

d. Then lay the other half-hexagons around the first one. The colour effect is obtained by respecting correctly the direction of installation of the half-hexagons.

- **Squaring** : check the alignment of the half-hexagons often.
- **Tightening** : check regularly to make sure the 4 sides of each half-hexagon are closely lined up.

Failure to comply with these rules may lead to a bad lining up and could thus generate gaps or openings in the seams.

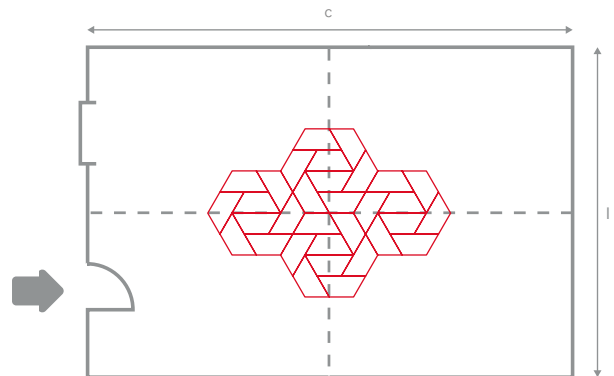

e. Smooth down the half-hexagons: this process is mandatory and must be done in two stages:



Smooth down the joints using the small seam roller.



Smooth down the entire flooring area using the large, heavy roller.

f. Repeat the smoothing process across the entire room.

> Laying of gammas

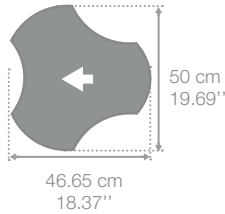

This type of shape can be laid in single-colour or several colours compositions.



Single-colour gammas pattern.



APPLICATION OF THE ADHESIVE

See the adhesive recommendations on page 6.
Follow the adhesive manufacturer's instructions to the letter and respect both the weight and timing specifications.

Implementation:

a. Draw two axes to determine the center of the room.

In order to have balanced cuts at the periphery of the room, start laying the gammas as described below.

b. Glue a surface of reasonable size so that the gammas can be applied in the glue during the working time of the glue.

c. Lay the first gamma down at the center of the room.

d. Then lay the other gammas around the first one. The colour effect is obtained by respecting correctly the direction of installation of the gammas.

- **Squaring** : check the alignment of the gammas often.

- **Tightening** : check regularly to make sure all the sides of each gamma are closely lined up.

Failure to comply with these rules may lead to a bad lining up and could thus generate gaps or openings in the seams.

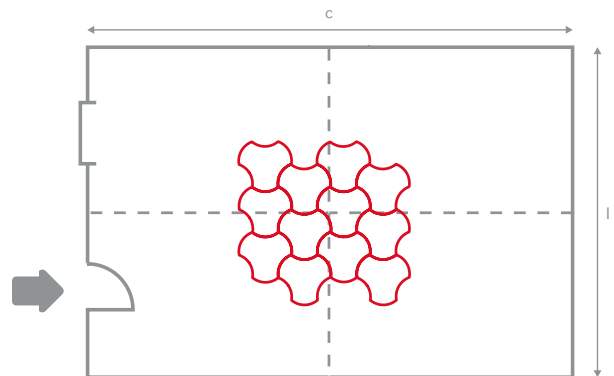

e. Smooth down the gammas: this process is mandatory and must be done in two stages:



Smooth down the joints using the small seam roller.



Smooth down the entire flooring area using the large, heavy roller.

f. Repeat the smoothing process across the entire room.

> Laying of prisms

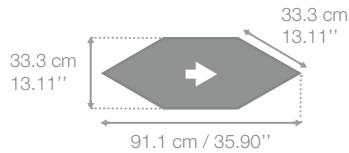

This type of shape can be laid in single-colour or several colours compositions.



Two-colour prisms pattern.



APPLICATION OF THE ADHESIVE

See the adhesive recommendations on page 6.
Follow the adhesive manufacturer's instructions to the letter and respect both the weight and timing specifications.

Implementation:

a. Draw two axes to determine the center of the room.

In order to have balanced cuts at the periphery of the room, start laying the prisms as described below.

b. Glue a surface of reasonable size so that the prisms can be applied in the glue during the working time of the glue.

c. Lay the first prism down at the center of the room.

d. Then lay the other prisms around the first one. The colour effect is obtained by respecting correctly the direction of installation of the prisms.

- **Squaring** : check the alignment of the prisms often.

- **Tightening** : check regularly to make sure the 6 sides of each prism are closely lined up.

Failure to comply with these rules may lead to a bad lining up and could thus generate gaps or openings in the seams.

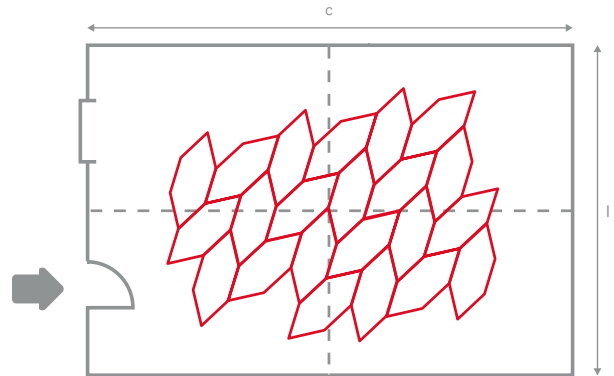

e. Smooth down the prisms: this process is mandatory and must be done in two stages:



Smooth down the joints using the small seam roller.



Smooth down the entire flooring area using the large, heavy roller.

f. Repeat the smoothing process across the entire room.

> Laying of triangles

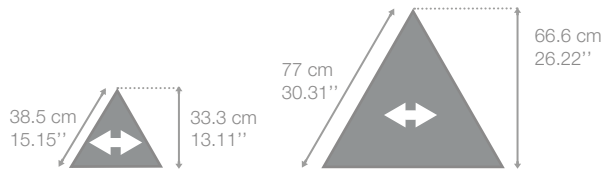

This type of shape can be laid in single-colour or several colours compositions.



Single -colour triangles pattern.



APPLICATION OF THE ADHESIVE

See the adhesive recommendations on page 6.
Follow the adhesive manufacturer's instructions to the letter and respect both the weight and timing specifications.

Implementation:

a. Draw two axes to determine the center of the room.

In order to have balanced cuts at the periphery of the room, start laying the triangles as described below.

b. Glue a surface of reasonable size so that the triangles can be applied in the glue during the working time of the glue.

c. Lay the first triangle down at the center of the room.

d. Then lay the other triangles around the first one. The colour effect is obtained by respecting correctly the direction of installation of the triangles.

- **Squaring** : check the alignment of the triangles often.

- **Tightening** : check regularly to make sure the 3 sides of each triangle are closely lined up.

Failure to comply with these rules may lead to a bad lining up and could thus generate gaps or openings in the seams.

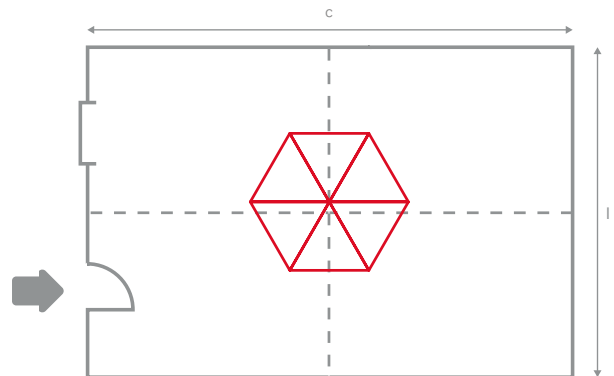

e. Smooth down the triangles: this process is mandatory and must be done in two stages:



Smooth down the joints using the small seam roller.



Smooth down the entire flooring area using the large, heavy roller.

f. Repeat the smoothing process across the entire room.

> Laying of multishapes planks and tiles patterns

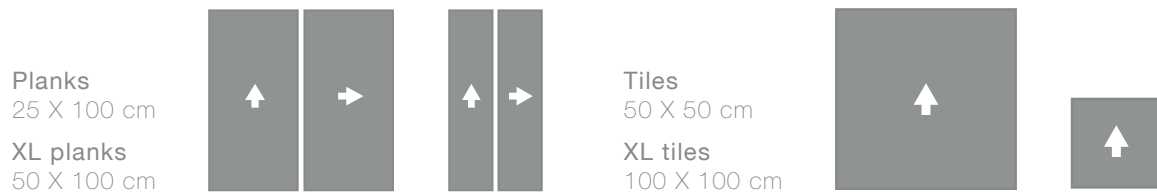

The shapes above can be laid together in one or several colours compositions depending on the expected effect.

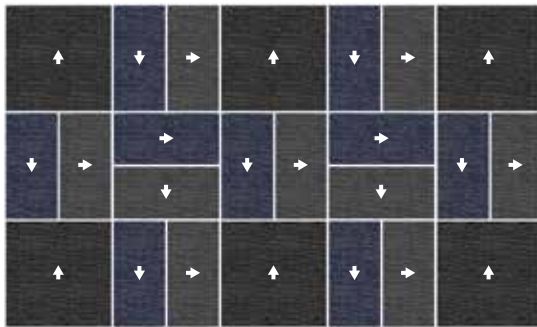

XL planks and XL tiles laid in a 2-colours pattern.



APPLICATION OF THE ADHESIVE

See the adhesive recommendations on page 6.
Follow the adhesive manufacturer's instructions to the letter and respect both the weight and timing specifications.

Implementation:

a. Draw two axes to determine the center of the room.

In order to have balanced cuts at the periphery of the room, start laying the shapes as described below.

b. Glue a surface of reasonable size so that the shapes can be applied in the glue during the working time of the glue.

c. Lay the first shape down at the center of the room.

d. Then lay the other shapes around the first one. The colour effect is obtained by respecting correctly the direction of installation of the shapes.

• **Squaring** : check the alignment of the shapes often.

• **Tightening** : check regularly to make sure all the sides of each shape are closely lined up.

Failure to comply with these rules may lead to a bad lining up and could thus generate gaps or openings in the seams.

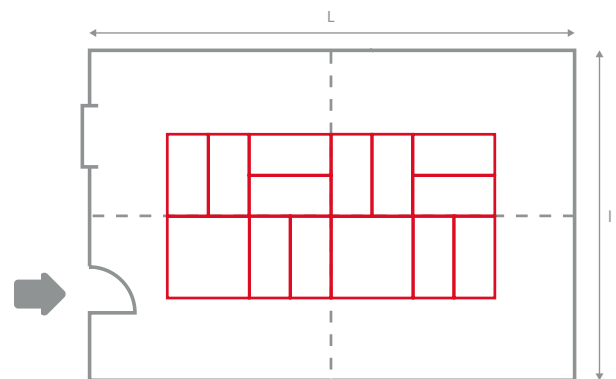

e. Smooth down the shapes: this process is mandatory and must be done in two stages:



Smooth down the joints using the small seam roller.



Smooth down the entire flooring area using the large, heavy roller.

f. Repeat the smoothing process across the entire room.

> Laying of multishapes triangles and semi-hexagons patterns

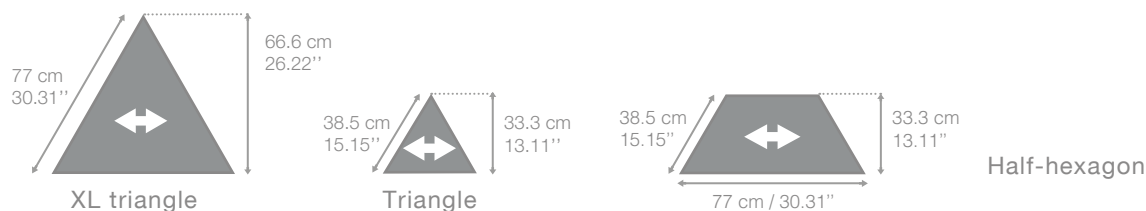

The shapes above can be laid together in one or several colours compositions depending on the expected effect.



Triangles, XL triangles and half hexagons laid in a 1 colour pattern.



APPLICATION OF THE ADHESIVE

See the adhesive recommendations on page 6.
Follow the adhesive manufacturer's instructions to the letter and respect both the weight and timing specifications.

Implementation:

a. Draw two axes to determine the center of the room.

In order to have balanced cuts at the periphery of the room, start laying the shapes as described below.

b. Glue a surface of reasonable size so that the shapes can be applied in the glue during the working time of the glue.

c. Lay the first shape down at the center of the room.

d. Then lay the other shapes around the first one. The colour effect is obtained by respecting correctly the direction of installation of the shapes.

• **Squaring** : check the alignment of the shapes often.

• **Tightening** : check regularly to make sure all the sides of each shape are closely lined up.

Failure to comply with these rules may lead to a bad lining up and could thus generate gaps or openings in the seams.

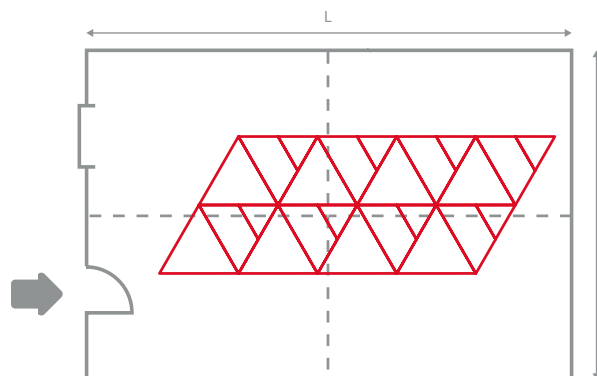

e. Smooth down the hexagons: this process is mandatory and must be done in two stages:



Smooth down the joints using the small seam roller.



Smooth down the entire flooring area using the large, heavy roller.

f. Repeat the smoothing process across the entire room.



WOVEN FLOORING

BY DICKSON



10 rue des châteaux
BP 109 - Z.I. la Pilaterie
59443 Wasquehal Cedex
France
Tél. + 33 (0)3 20 45 59 59
www.dickson-constant.com

DICKSON® Performance fabrics for:
solar protection - outdoor furniture - indoor furniture
marine furnishing - flooring